

# TCF

TCF-142	.....	2
1 TCF-142 RS-232/422/485	.....	2
2	.....	3
3	.....	4
4	.....	5
TCF-90	.....	6

MOXA  
2017-10

# 1 TCF-142 RS-232/422/485

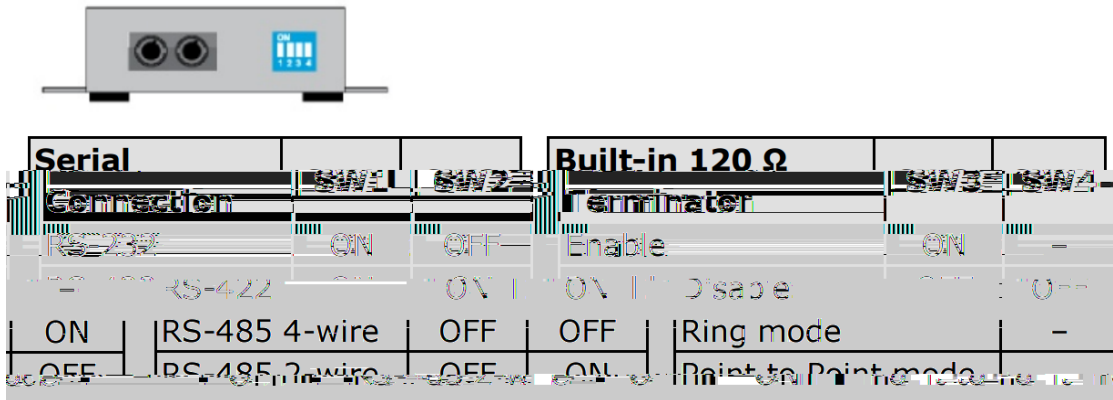

- SW3 120
- SW4

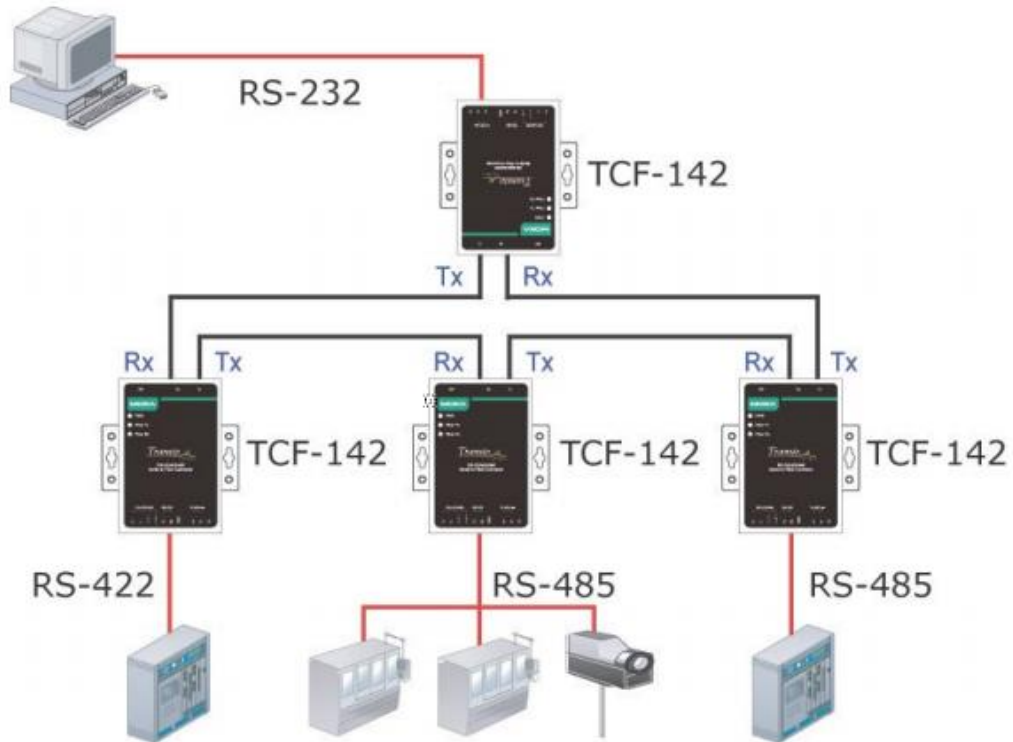

- RS485



2

RS422 RS485

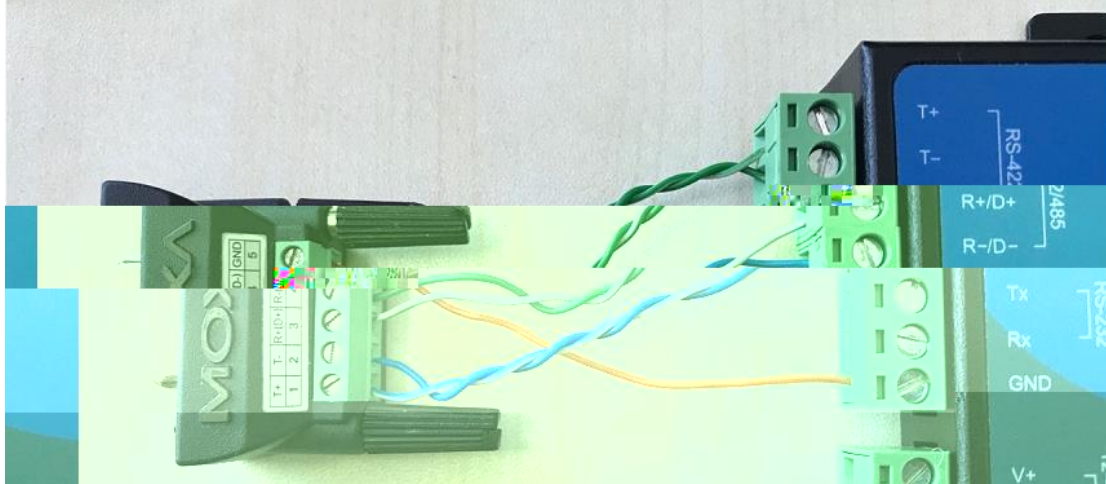
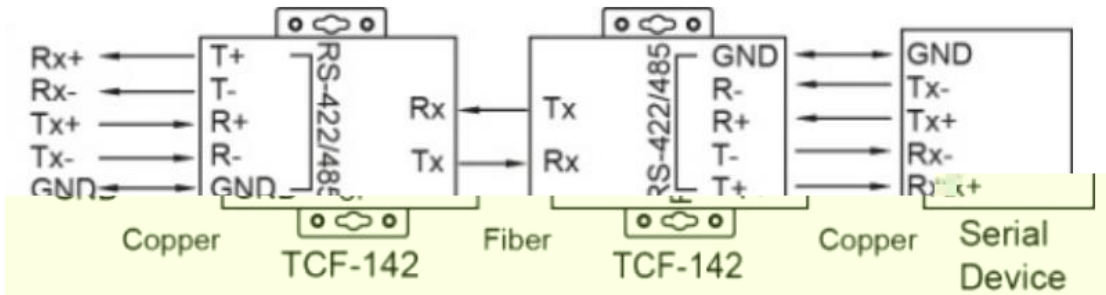

RS485

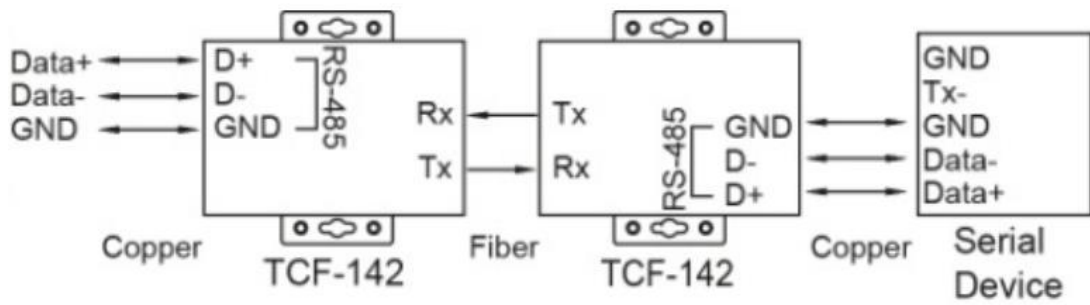



TX RX

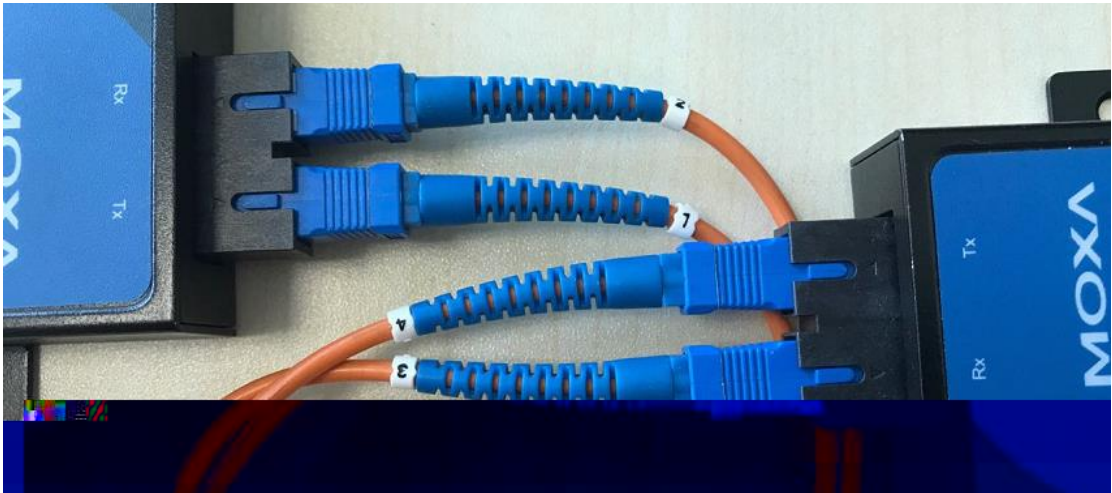

4

1 PC PComm Lite – Serial MOXA  
<http://www.moxa.com/support/DownloadFile.aspx?type=support&id=167>

2 PC TCF USB



3 PC PComm Terminal Emulator

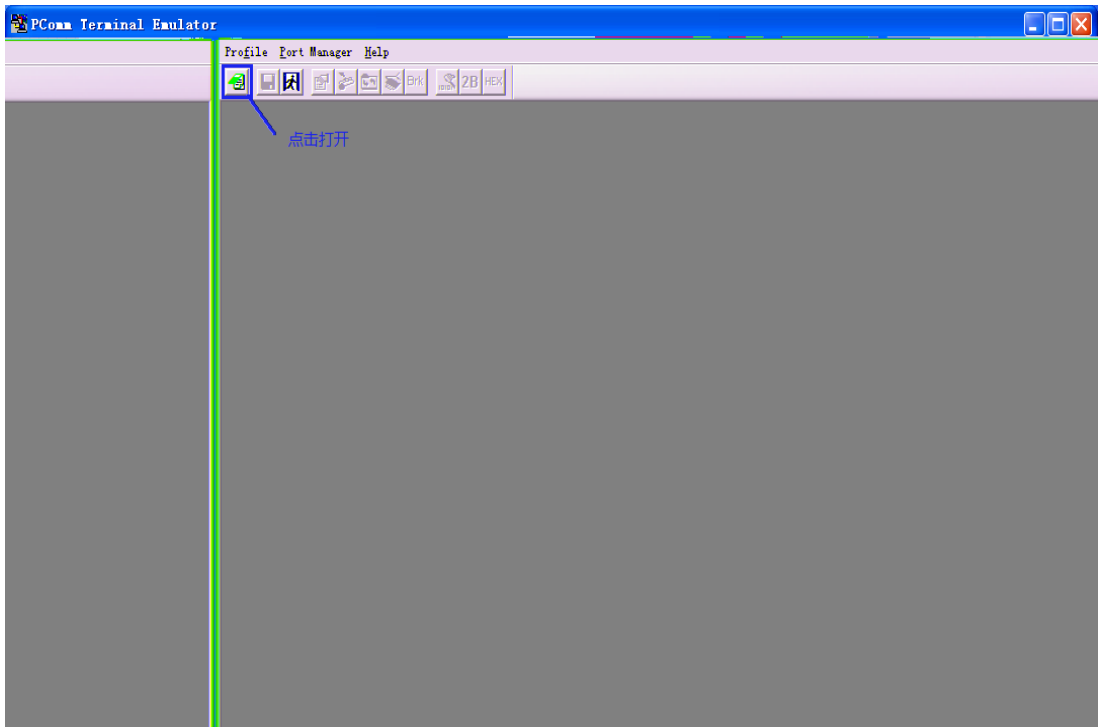

4

“ Serial”

PC

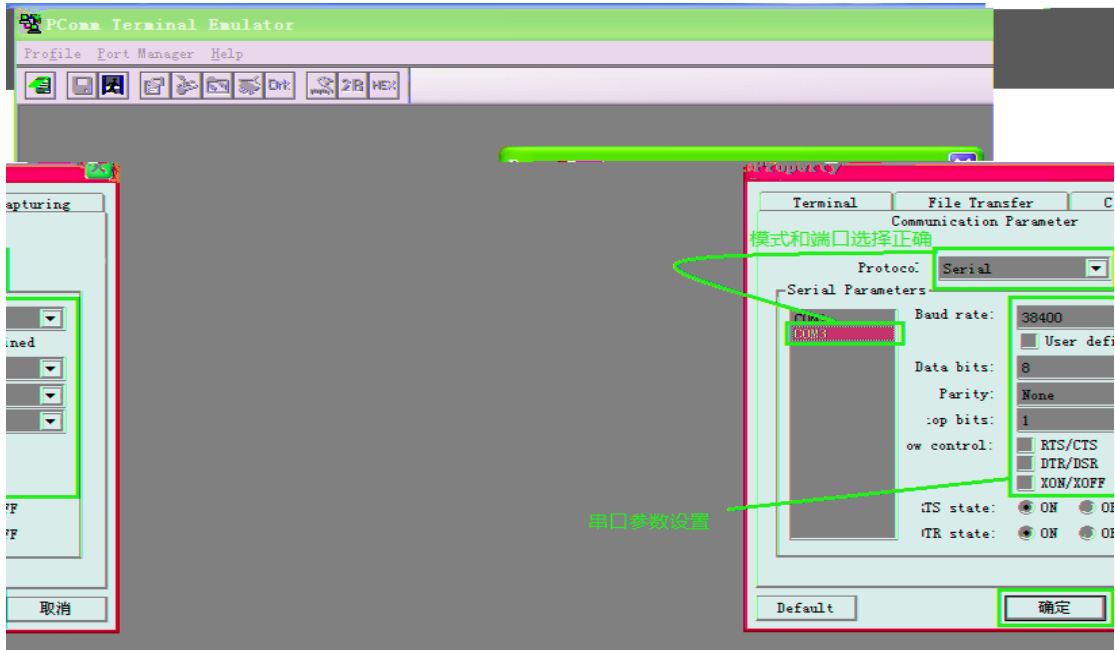

5 PC1

PC2

PC2

PC1

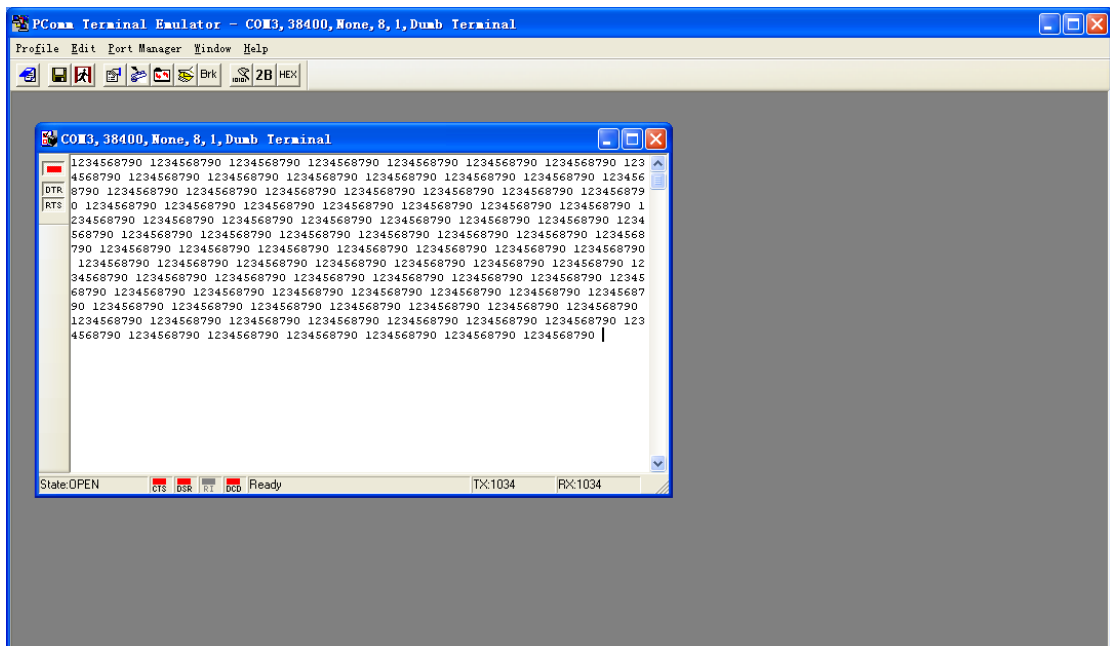

1 DB9

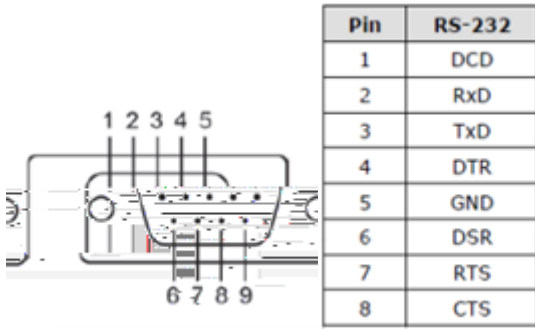

2 TCF-90

SW4



- 
- 

LED

TCF-90

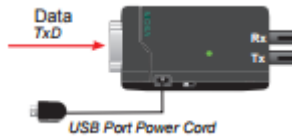

3

TCF-90

TCF-142